

York Twin Shower

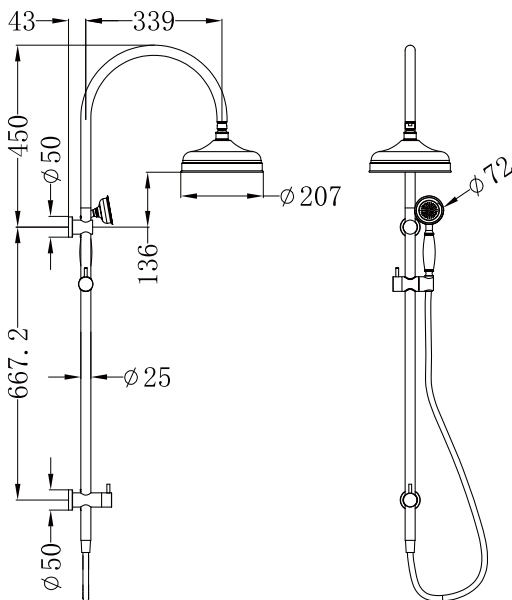

Dimensions are nominal measurements only.



Versions: V1

SPECIFICATION

OVERHEAD SHOWER	3STAR 9L/MIN
HAND SHOWER	3STAR 9L/MIN
WATERMARK LICENSE	WM-060093
TEMPERATURE RATING	MIN 1°C-MAX 75°C
PRESSURE RATING	MIN 150KPa-MAX 500KPa

FINISH

	CHROME WITH WHITE POCELAIN HAND SHOWER NR69210501CH
	CHROME WITH METAL HAND SHOWER NR69210502CH
	MATTE BLACK WITH WHITE POCELAIN HAND SHOWER NR69210501MB
	MATTE BLACK WITH METAL HAND SHOWER NR69210502MB
	AGED BRASS WITH WHITE POCELAIN HAND SHOWER NR69210501AB
	AGED BRASS WITH METAL HAND SHOWER NR69210502AB

MAINTENANCE AND CARE

All surfaces should be cleaned with mild liquid detergent or soap and water.

Do not use cream cleaners or citrus based cleaning products, as they are abrasive.

Use of unsuitable cleaning agents may damage the surface. Any damage caused in this way will not be covered by warranty

PACKING INCLUDES

- 1x hand shower (built-in check valve)
- 1x shower head
- 1x shower arm
- 1x shower rail
- 1x 1.5m hose
- 2x back plates
- 1x installation kit

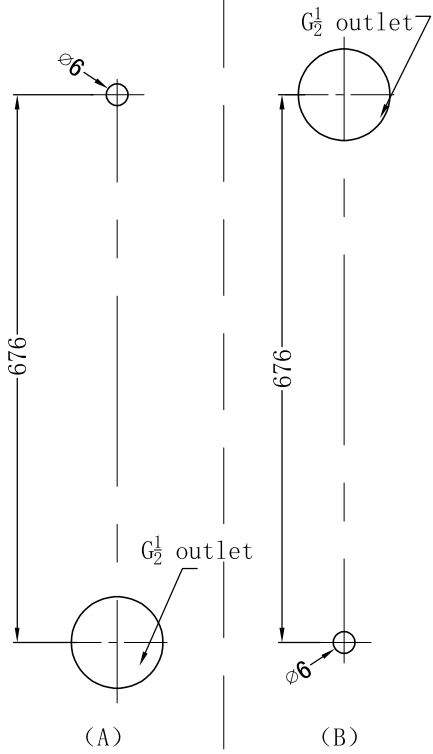

1. Drill a $\phi 6\text{mm}$ hole at the 575mm downwards or upwards outlet vertical downward or upward position, as the picture A and B.



2. Screw the adapter onto the outlet. Push wall plug into drilled hole. Fit lower mounting pillar in place with screw. Tighten firmly.

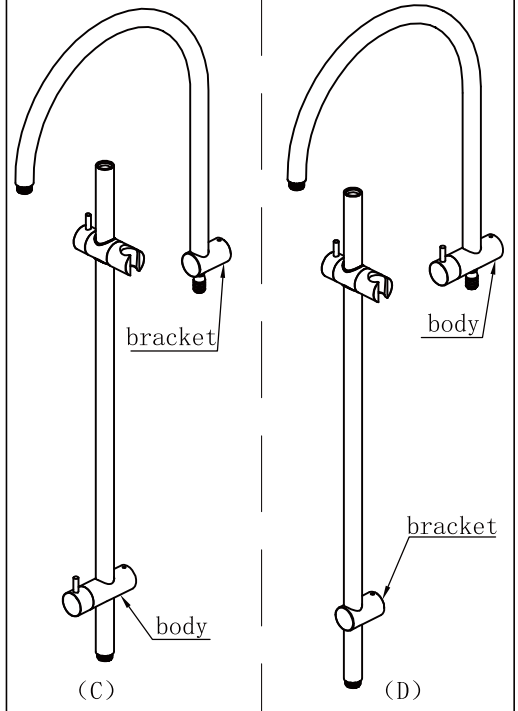

3. If you make hole as picture A, then you should install as picture C. You can ignore step 4 and install as step 5.

If you make hole as picture B, then you should install as picture D. Then you need to change place of body and bracket as step 4.

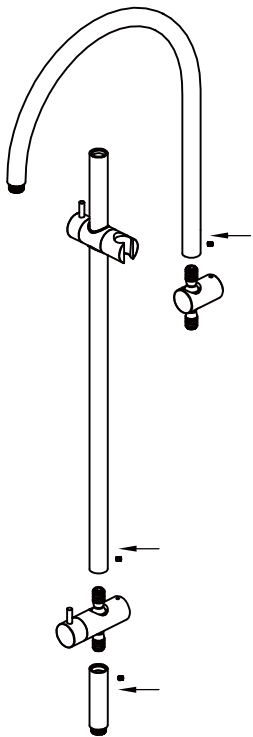

4. Unscrew 3 grub screws as picture and unplug short shower rail, long short rail and shower arm one by one. Change the place of body and bracket. Then plug in short shower rail, long shower rail and shower arm and screw the 3 grub screws.

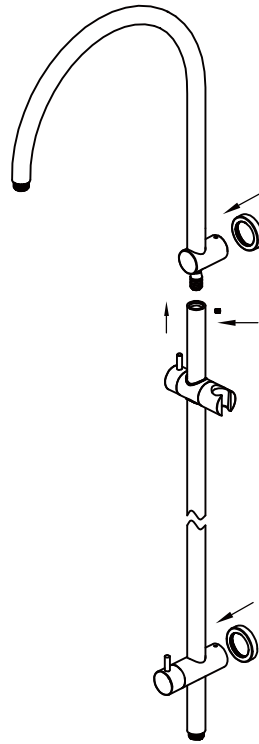

5. Screw shower rail into shower arm component. Tighten firmly. Push 2 back plates onto shower arm component and body

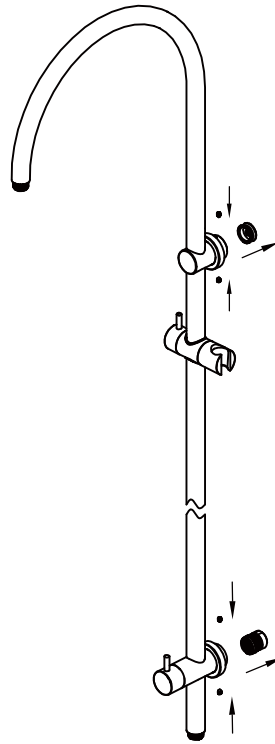

6. Locate and put shower rail assembly onto wall adaptors. Tighten grub screws firmly with allen key provided.

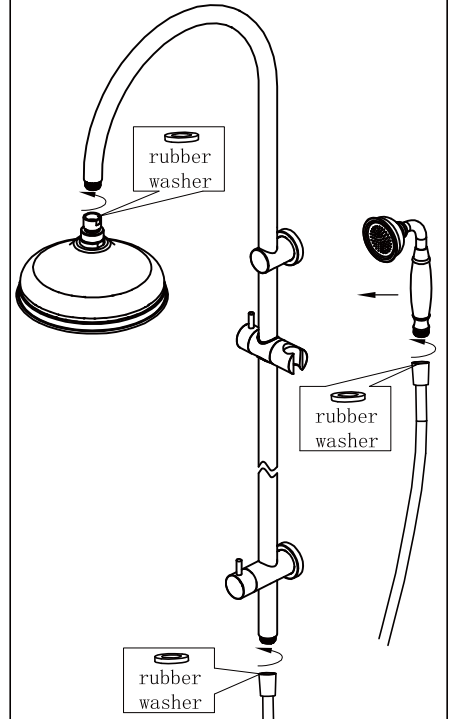

7. Screw shower head to shower are with care. (Note the rubber washer in the shower head.) Connect shower rail and hand shower with hose. (Note rubber washer in the hose.)
TEST & CHECK FOR LEAKS.